

OCARIZ INOX AISI 304 DIN 1.4301

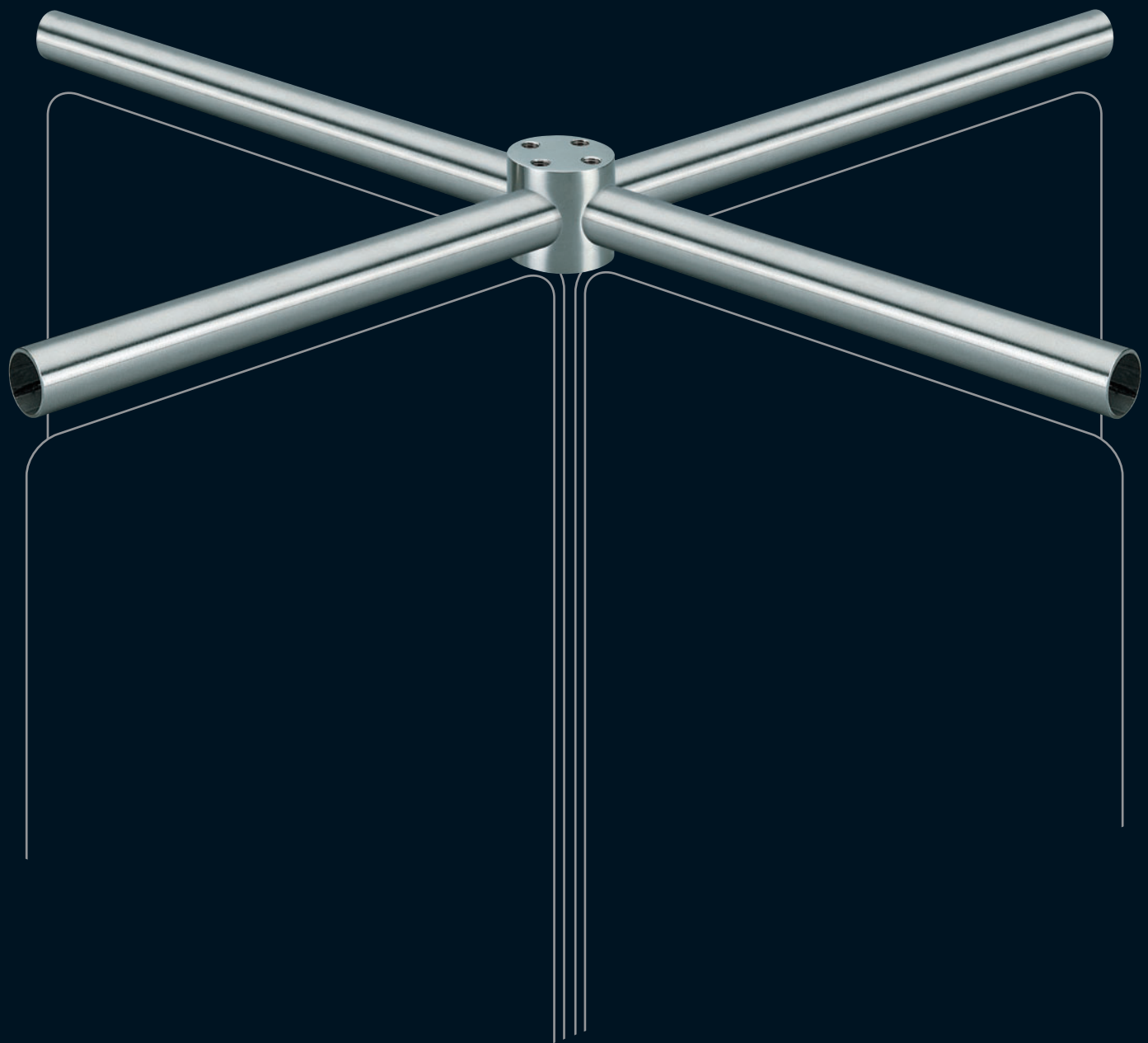

**HERRAJES PARA
CABINAS SANITARIAS
(PARTICIONES)**



REFERENCIA

81/654TO 94/654TO

CONDENA DE PRIVACIDAD

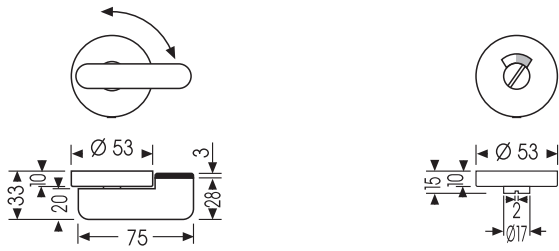
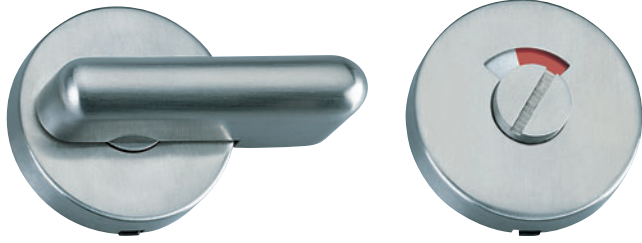

REFERENCIA

83/654 94/654

CONDENA DE PRIVACIDAD

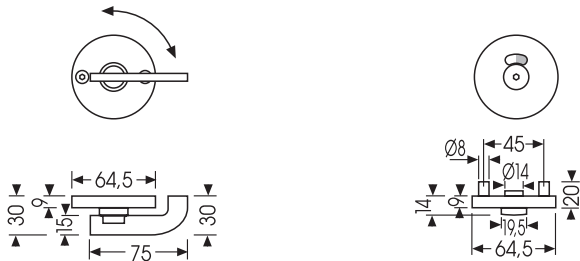
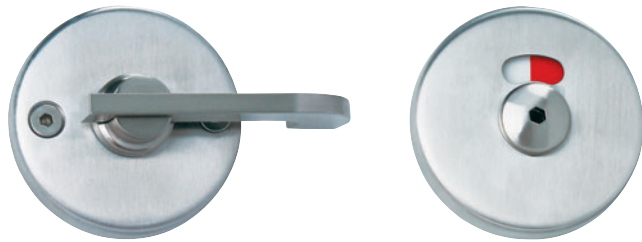

ACABADO MATE



REFERENCIA

170-R

BISAGRA PLANA SIN MUELLE

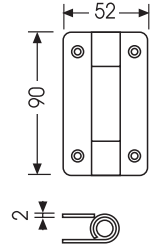

REFERENCIA

171-R

BISAGRA PLANA CON MUELLE

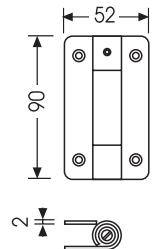

REFERENCIA

172-R

PERNIO PLANO SIN MUELLE

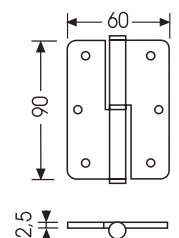

REFERENCIA

173-R

BISAGRA PARA TAQUILLAS

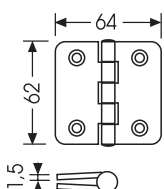

REFERENCIA

227

JUEGO DE POMOS FIJOS

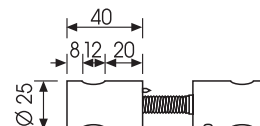
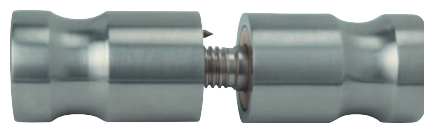

REFERENCIA

570

SOPORTE PIE REGULABLE EN ALTURA

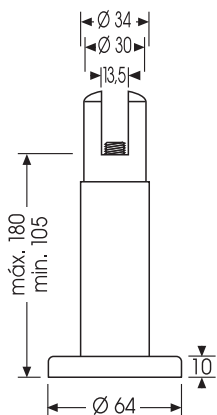

REFERENCIA

580

TOPE DE PUERTA-COLGADOR

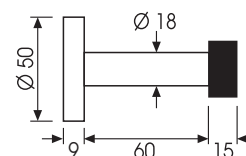

REFERENCIA

226

JUEGO DE POMOS FIJOS

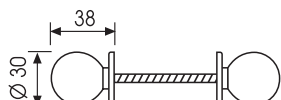
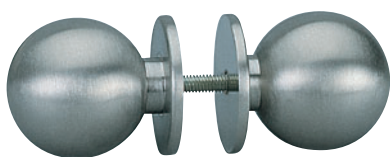

REFERENCIA

585

PINZA DE SUJECCIÓN

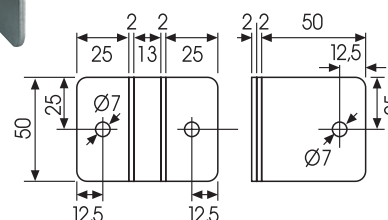

ACABADO MATE



REFERENCIA

586

PINZA DE SUJECCIÓN

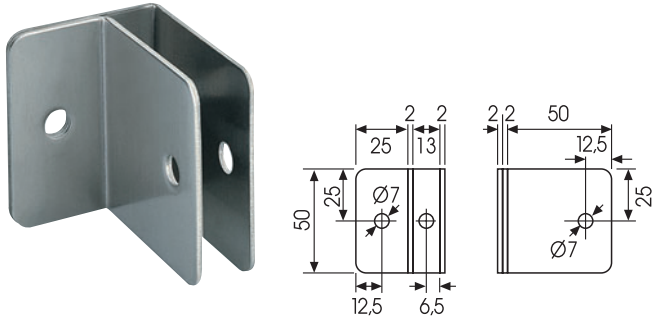

REFERENCIA

587

PINZA DE SUJECCIÓN

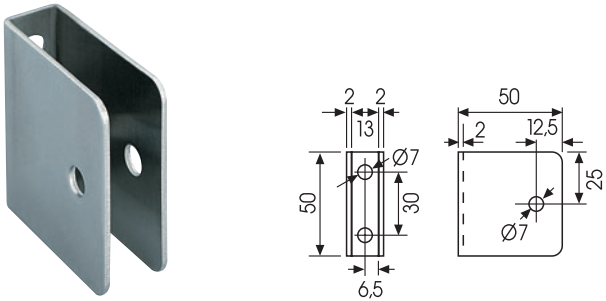

REFERENCIA

588

PINZA DE SUJECCIÓN

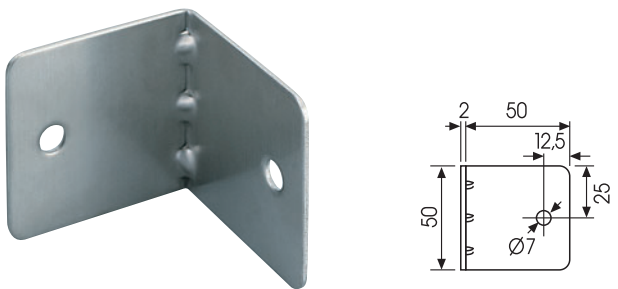

REFERENCIA

589

SOPORTE TUBO PARED

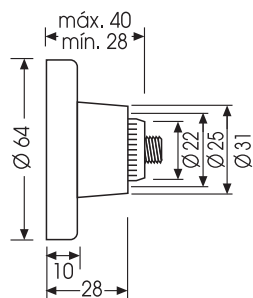

ACABADO MATE



REFERENCIA

590

NUDO TUBO "L"

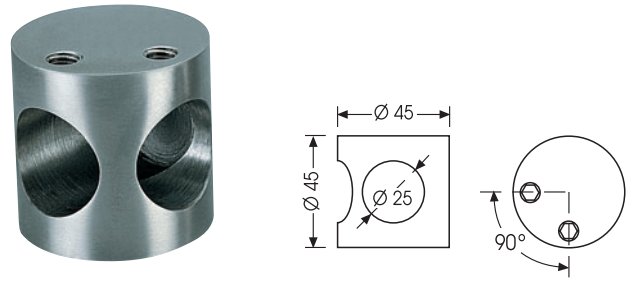

REFERENCIA

591

NUDO TUBO "T"

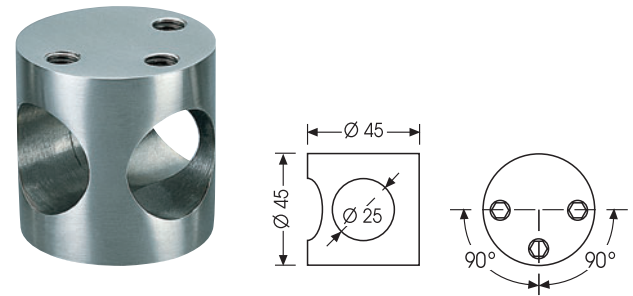

REFERENCIA

592

PINZA DE SUJECCIÓN TUBO PANEL

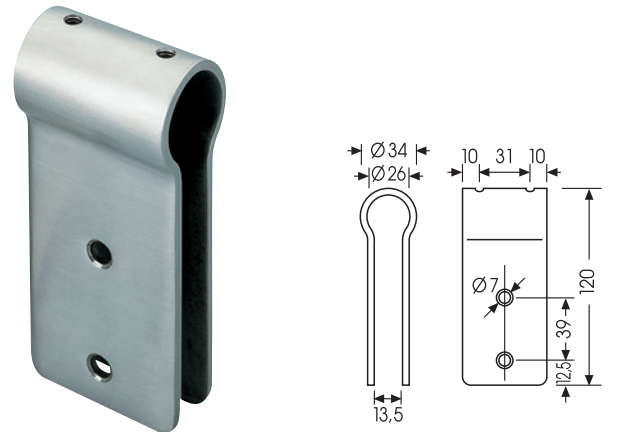

REFERENCIA

593

NUDO TUBO "+"

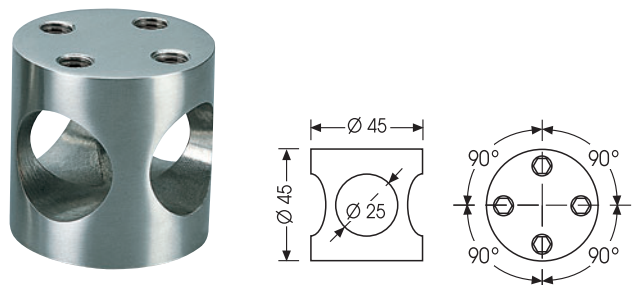

REFERENCIA

594

TUBO

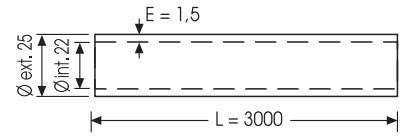

REFERENCIA

595/1800

PERFIL "U"

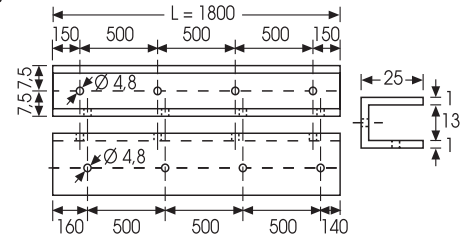

595/1850

PERFIL "U"

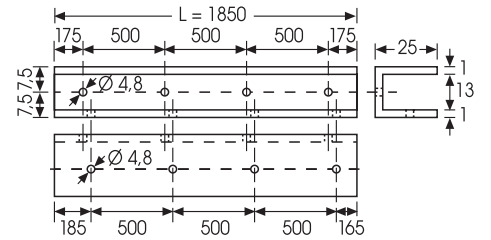

REFERENCIA

596

PERFIL "L"

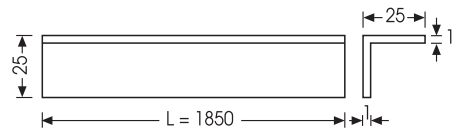
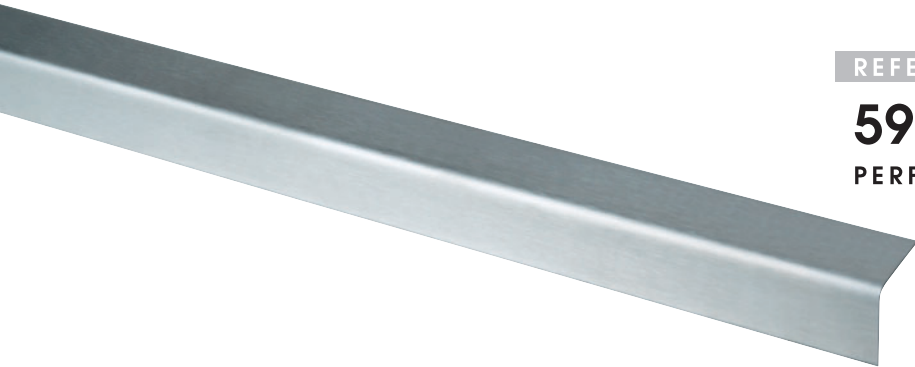

REFERENCIA

597

PERFIL "U" SUPERIOR

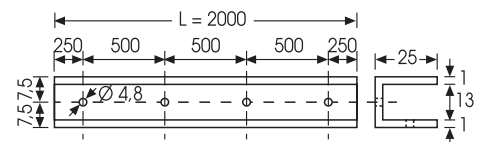

ACABADO MATE



EJEMPLO BÁSICO DE APLICACIÓN

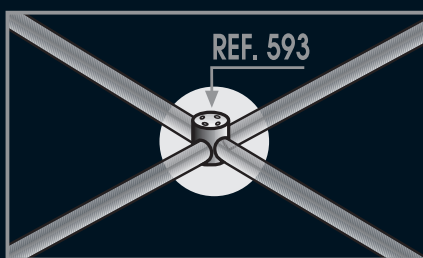
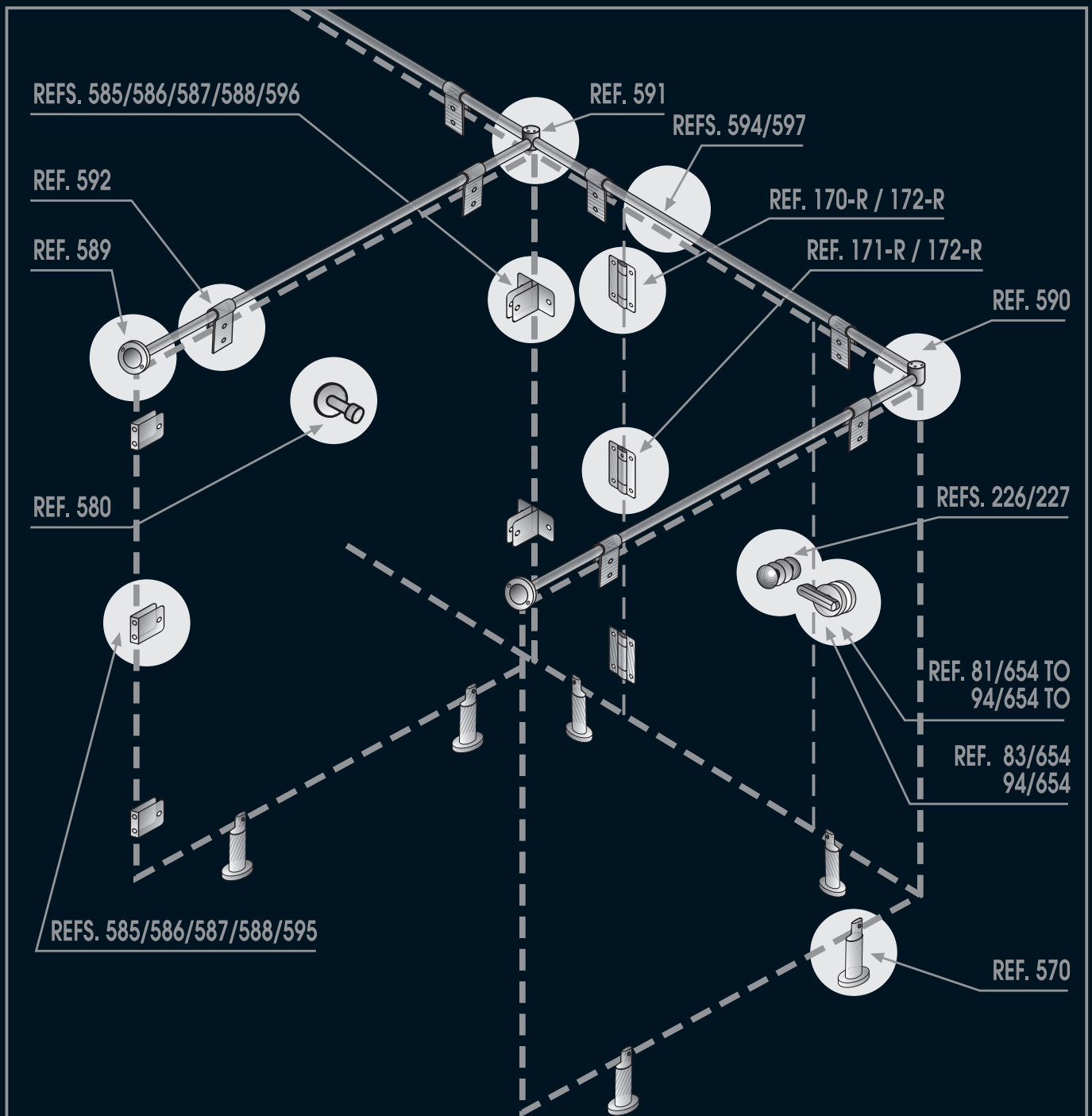

www.ocariz.es

DOMICILIO SOCIAL
 PORTAL DE BETOÑO, 16
 01013 VITORIA-GASTEIZ
 TEL. 945 26 34 00
 TEL. (INT.) 34-945 26 34 00
 FAX. 945 26 32 88
 FAX (INT.) 34-945 26 32 88
 APDO./P.O. Box 95
 01080 VITORIA-GASTEIZ
 ESPAÑA - SPAIN
 E-MAIL: ocariz@ocariz.es

FABRICA
 CARRETERA DE VERGARA, 17
 01013 VITORIA-GASTEIZ